

Chevrolet (Standard Key)											
Avalanche	07	08	09	10	11	12	13				
Express		08	09	10	11	12	13	14	15	16	17
Express 2500		08	09	10	11	12	13	14	15	16	17
Express 3500		08	09	10	11	12	13	14	15	16	17
Silverado 1500	07	08	09	10	11	12	13				
Silverado 2500	07	08	09	10	11	12	13	14			
Silverado 3500	07	08	09	10	11	12	13	14			
Suburban	07	08	09	10	11	12	13	14			
Tahoe	07	08	09	10	11	12	13	14			
GMC (Standard Key)											
Savana (also 18-23)		08	09	10	11	12	13	14	15	16	17
Sierra 1500	07	08	09	10	11	12	13				
Sierra 2500	07	08	09	10	11	12	13	14			
Sierra 3500	07	08	09	10	11	12	13	14			
Sierra HD	07	08	09	10	11	12	13	14			
Yukon	07	08	09	10	11	12	13	14			
Cadillac (Standard Key)											
Escalade	07	08	09	10	11	12	13	14			

•This remote start will monitor the vehicle lock circuit and use the pulses generated by pressing Lock>Unlock>Lock on your OEM remote to start the vehicle.

•This is a pre-wired "plug & play" kit. No wired connections are required in the vehicle for installation. There are other loose wires in the t-harness . They are not used in this installation.

•We have already loaded the correct firmware into the remote start module. You will need to pair the module to your vehicle when the wiring is complete. Instructions are on page 3.

Step 1: Download and install Flash Link Manager software

**The Flash Link Manager (FLM) software only works on a Windows computer and requires a USB port and an internet connection. Enter the following link into your web browser, then download and install the software:

<https://fortin.ca/en/support/flashlinkmanager.html>

Next, open the software and log in with the following credentials: **email: flash@kleinn.com** **password: Flash2020**

Once the (FLM) software is installed and open, connect the Flash Link Updater to the USB port of your Windows computer. The (FLM) software will detect the Updater and then display a message that the module is not connected - this is normal. Do not plug the remote starter into the (FLU) tool until you have completed the wiring and vehicle programming procedure at step 2. Leave the computer and software in this state ready to plug the module in when the time comes, and proceed with the wiring connections.

Step 2: Plug-In Connections

- a. Remove the steering column cover.
- b. Unplug the ignition plug from the vehicle, then plug the male t harness plug into the vehicle and then plug the factory ignition plug into the female side of the t harness.
- c. Repeat Step 2b with the transponder plug in the vehicle. The wiring is now complete.

System Wiring Diagram

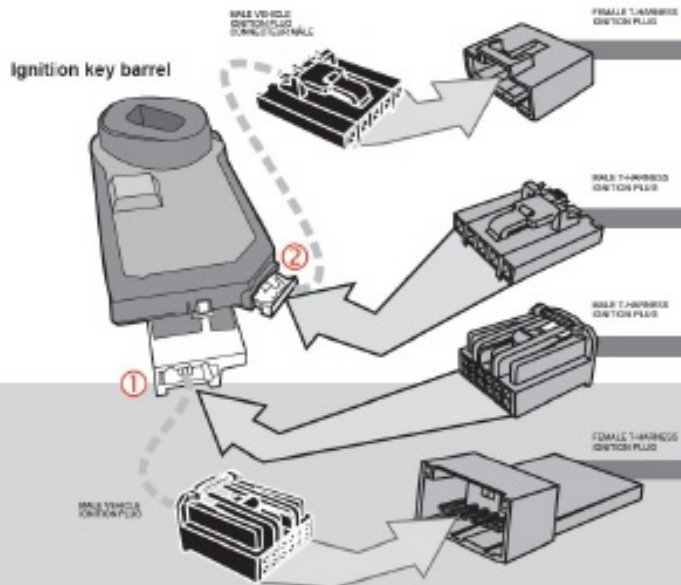
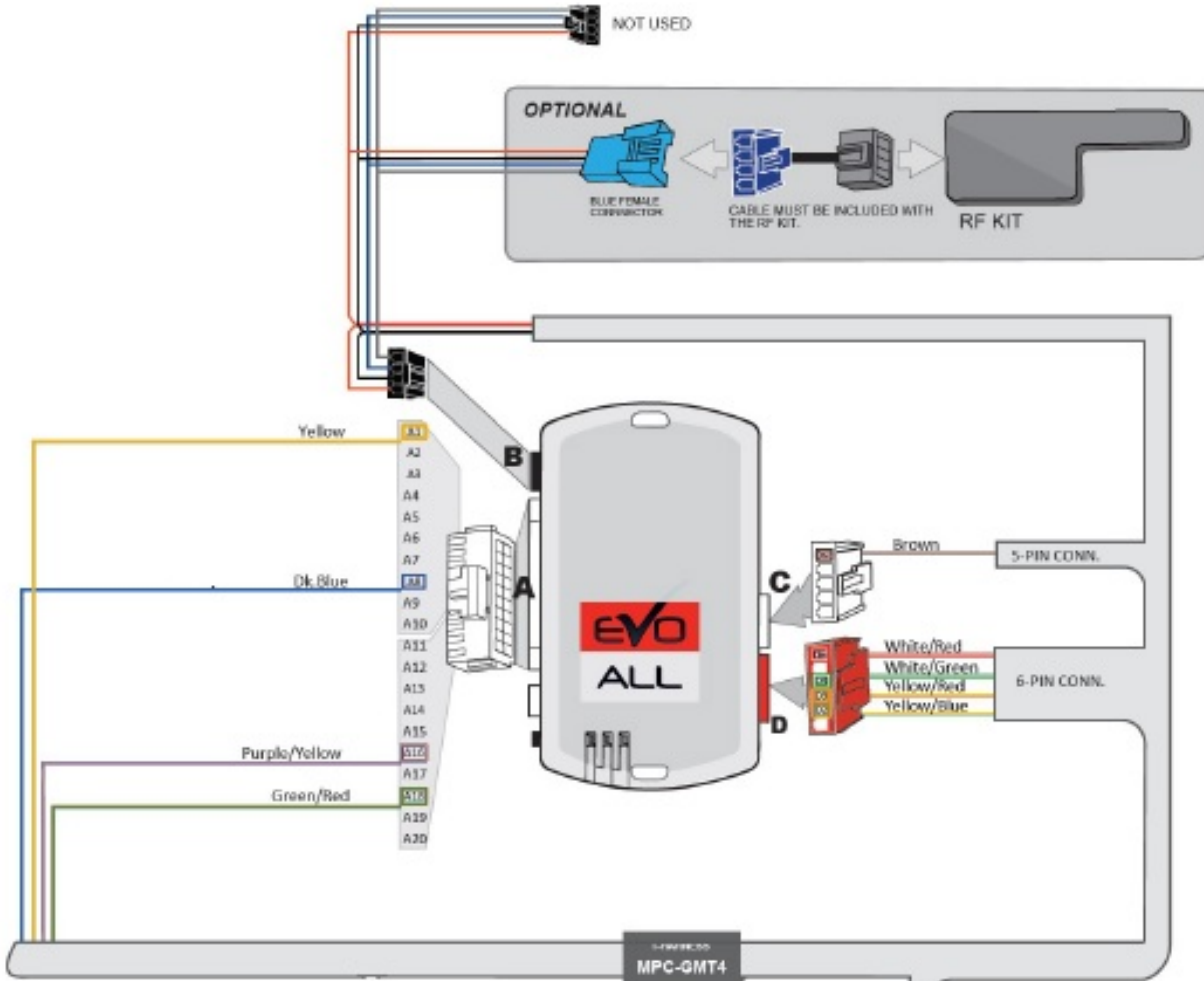

Step 3: Programming.

1

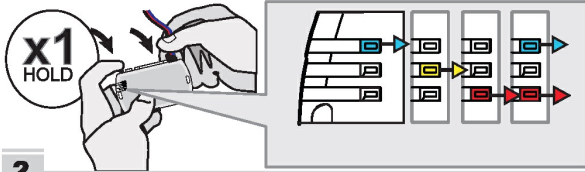

Press and hold the programming button:
Connect the 4-PIN Data-link harness (Black connector).

↳ The Blue, Red, Yellow and Blue & Red LEDs will alternatively illuminate.

2

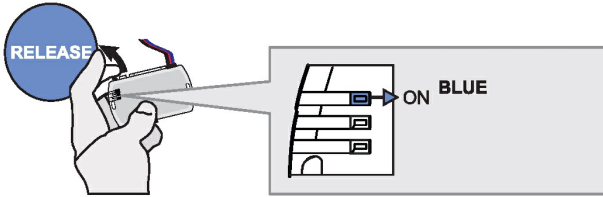

Release the programming button when the LED is BLUE.

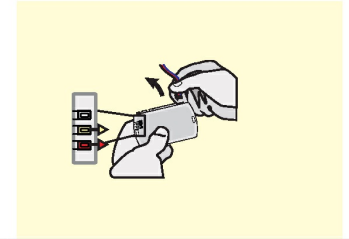

3

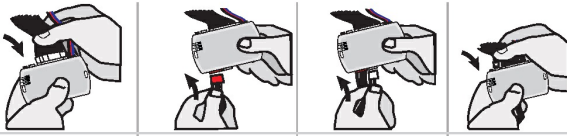

Insert the required remaining connectors.

4

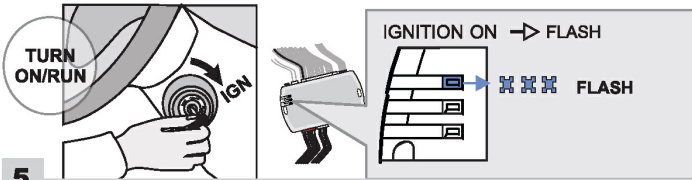

Turn the key to the Ignition ON/RUN position.

↳ The Blue LED will flash rapidly.

5

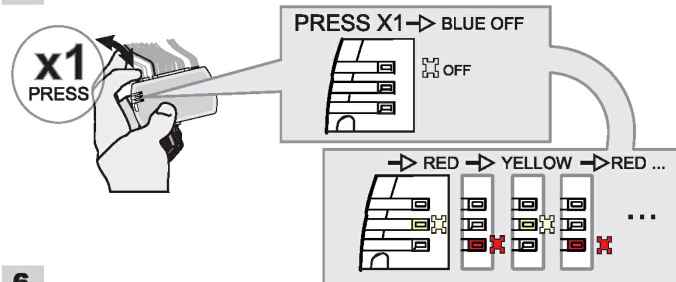

Press and release the programming button once (1x).

↳ The Blue LED will turn OFF.

↳ The YELLOW and RED LEDs will alternate..

6

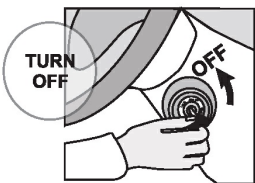

Turn the key to the OFF position.

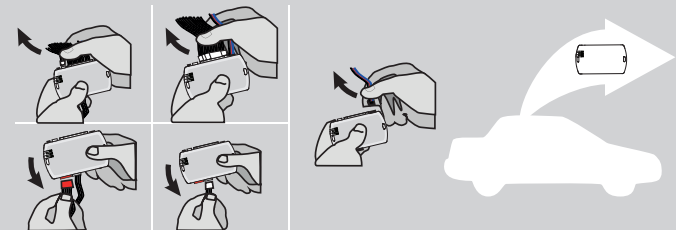

Disconnect all the connectors and after the Data-Link (4-pins) connector.



FLASH LINK UPDATER*

FLASH LINK MANAGER*
 SOFTWARE | PROGRAMME

Microsoft Windows
 Computer with
 Internet connection*

Ordinateur Microsoft
 Windows avec
 connection Internet*

Use the tool:
FLASH LINK UPDATER

Follow the instructions on
 Page 4

Step 4: Dcryptor

Next, it's time to bring the remote starter module to your computer and plug it into the supplied four-pin plug from the Flashlink Updater (FLU). For a video on how to do these steps visit: www.kleinn.com/flashlink



- The software will detect you plugging it in and will automatically load the current settings.
- Next, click the Dcryptor tab. Then click on the Send data button.

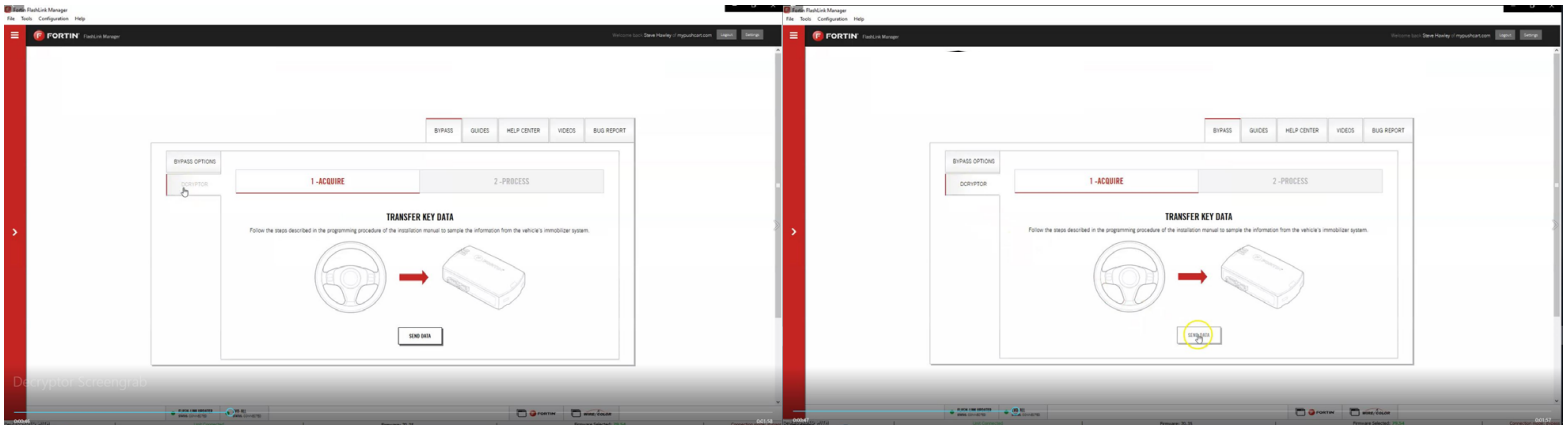

Wait while the updater reads data from the remote starter. Once it is done it will update the remote starter and you will need to wait again. You will see a status bar at the bottom of the screen. When it gets to 100%, the Dcryptor process is complete.

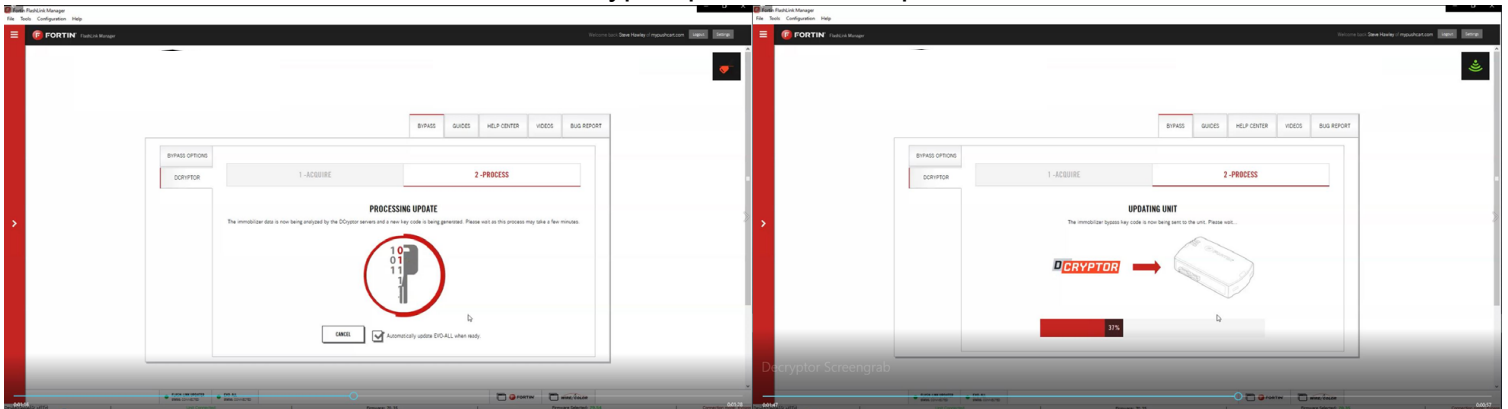

You can now unplug the remote starter module and plug it back into the connectors in your vehicle. Make sure to plug in the power connector first and then the rest of the plugs afterward. **Do not hold the program button down when you plug the connectors back in.**

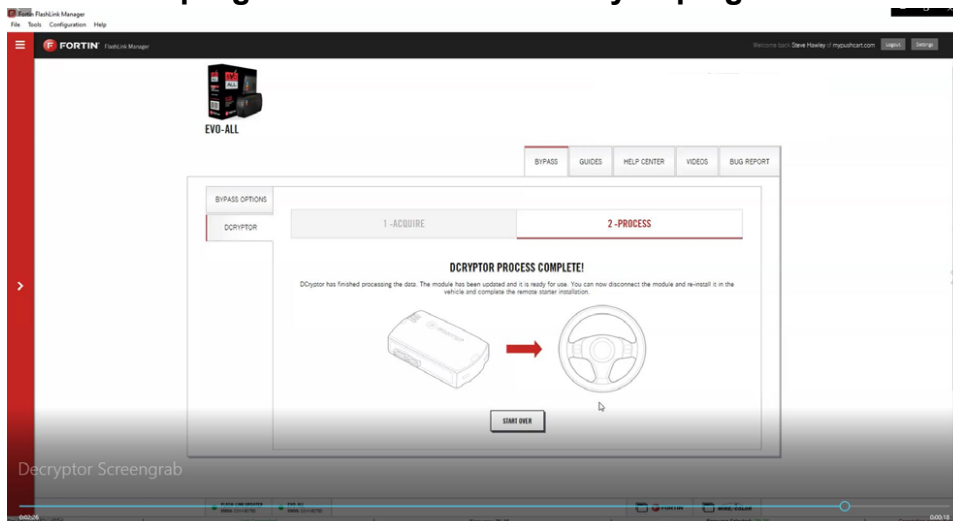

Step 5: Test the System

1. Press "Lock>UNLOCK>Lock" on your OEM remote control. You will see the Blue light on the remote start module every time you press the Lock or Unlock buttons. Each press should be about 1 second apart. The vehicles ignition/ accessory circuits will turn on after a few seconds. Another few seconds later the starter motor will engage.
2. Step on the brake pedal to stop the engine.

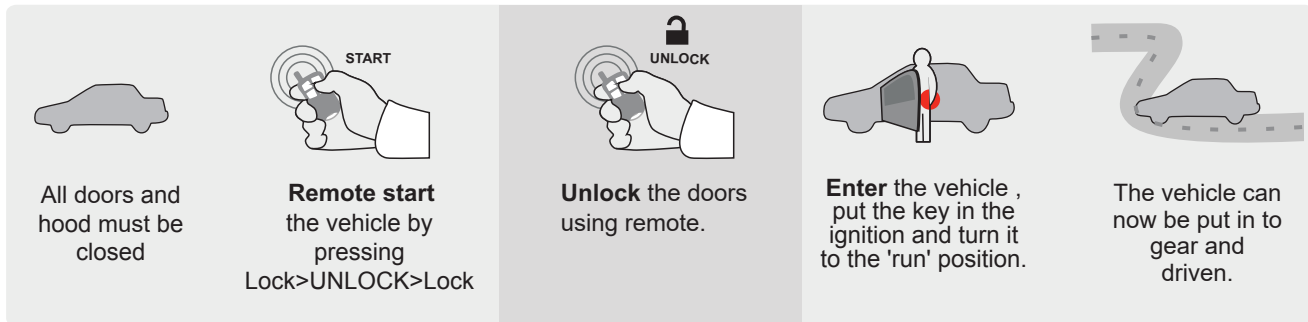

Step 6: Close it Up

Now gather up all of your wiring and neatly bundle it together using zip ties or electrical tape. Find a secure place to put the remote start module and use zip ties to secure it. **Make sure that the remote start wires are not near any moving parts on the steering wheel, pedals or emergency brake! Re-Install any panels that were removed to gain access to key switch in reverse order they were removed. Be careful not to pinch any wires. ENJOY!**

Parts List

- EVO-ALL Remote Start Data Module
- THAR-GM4 T-Harness

If you have any installation questions or problems, call for tech support

520.579.1531

Copyright 2024 Kleinn Automotive Accessories